

Table of contents

	Page
Overview	P2

NT 1000 Level monitoring via touch screen visualisation	P4

NT 2000 Level monitoring via control cabinet visualisation	P6

NT 3000 Level monitoring via web server visualisation (via Ethernet)	P8

Accessories NT 10 / 20 / 30 / 40 Display units - digital or analogue	P11

Subject to technical change.

Valid from 01.04.2009 until 31.03.2010 unless otherwise agreed.

All dimensions in mm (inches).

By publishing this option list all other option lists become invalid.

We assume no liability for typing errors.

Different variations to those specified are possible.
Please contact our technical consultants.







Overview

Silo plant with continuous level measurement technology, level limit sensors and shut off valves in the filling pipes.

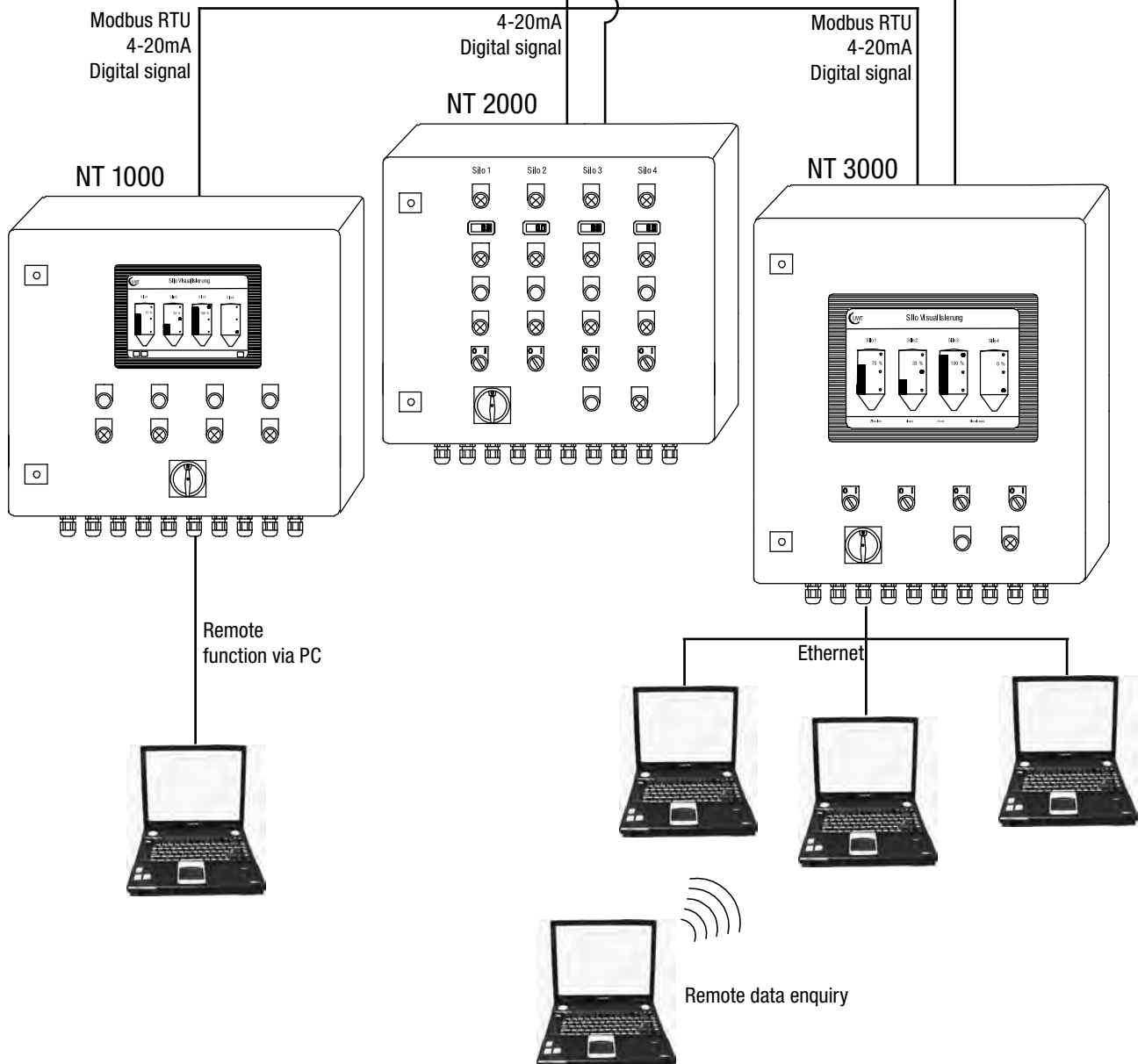
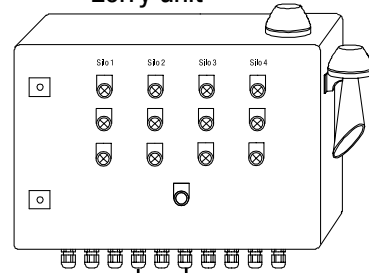

Lorry unit



	NT 1000	NT 2000	NT 3000
			
System	Touch panel 5.7" for simple display of contents and levels.	Control cabinet system for display and monitoring of contents with digital instrumentation and LEDs for level limits.	Control cabinet system for display and monitoring of contents and levels. The self contained system works with visualisation software on a web server.
Software	Licence free visualisation software for the display of the fill level and trends in the silos and vessels.	Not available	Licence free visualisation software in HTML form. Access via Explorer software and is password protected on the Ethernet-PCs.
Control cabinet	Optional	Part of the standard equipment	Part of the standard equipment
Input signal	- Modbus RTU of UWT Nivowave® - Up to 8 analogue inputs 4- 20mA - up to 14 digital inputs	- any number of analogue and digital inputs	- Modbus RTU of UWT Nivowave® - any number of analogue and digital inputs - Profibus available on request
Alarm signal Silo-„full“	Not available	Optional - Full signal available as a buzzer or flashing light	Optional - Full signal available as a buzzer or flashing light
Display in the control cabinet door	- Touch panel 5.7"	- Digital fill level NT 10 for contents display. - LED for full and empty signal	- Touch panel 7" - Touch panel 12.1" - Digital display and LED for full and empty detection
Remote data request	Not available	Not available	Optional Remote data request via modem.
Data storage	Not available	Not available	Optional The fill levels are recorded on a Flash Card which can be read out via a menu in the visualisation software on all PCs connected to the Ethernet. The data is in txt format.
Trends	Always with trends. The trends can be shown on the touch panel	Not available	Optional The trends can be shown on the touch panel
Lorry user module	Not available	Optional - Mounting on the silo equipment - Display Silo „full“ via LED and buzzer or flashing light	Optional - Mounting on the silo equipment - Display Silo „full“ via LED and buzzer or flashing light
Terminal box	Optional - mounted on the silo frame - to clamp between the measurement instrumentation signals	Optional - mounted on the silo frame - to clamp between the measurement instrumentation signals	Optional - mounted on the silo frame - to clamp between the measurement instrumentation signals
Shut off valve control	Not available	Optional - Release via key switch - Automatic via full detection	Optional - Automatic via full detection - Release via key switch, Mouse click or operator panel, Transponder, chip or barcode scanner is possible
Interfaces	- Modbus RTU RS 485 - Ethernet - RS 232	Not available	- Modbus RTU RS 485 - Profibus - Ethernet

NT 1000

Characteristics

- Fill level visualisation on a 5.7" touch panel
- Clearly arranged and easy to use visualisation software
- Versatile setting of the display parameters
- Easy expansion of the silo display up to 50 silos
- PC remote enquiry
- Fill level trend analysis

NT 1000 as a fixture

The NT 1000 is a 5.7" touch panel with software for visualisation of levels from silos and vessels. Applications can be in bulk solids or liquids. It can be mounted in an existing control cabinet and connected with the signal outputs and interfaces of the measurement technology. The power supply is 24 VDC. It evaluates 4-20mA analogue signals, digital signals from level sensors or also the Nivowave® Modbus RTU sensors via an RS485 interface.



NT 1000 integrated in control cabinet

The NT 1000 can be wired and mounted as a complete system in the control cabinet. The sensor signals and the supply voltage then only need to be connected according to the project based electrical planning. If electromechanical plumb bob systems are connected, the relevant user elements such as start button, alarm signal and end stop signal are installed on the control cabinet door.

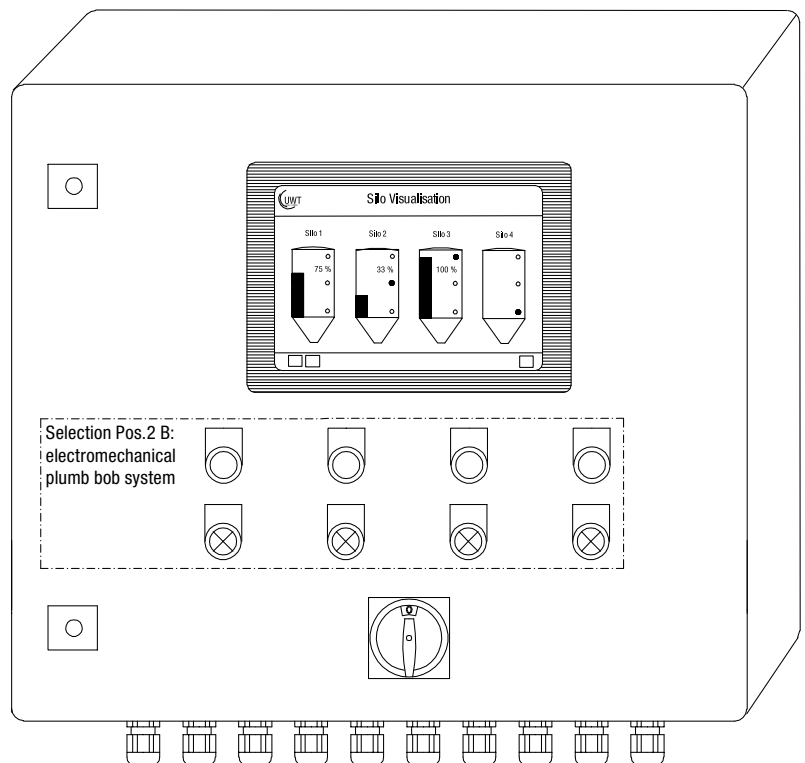

The drawing shows the sequence and principal positioning of the elements for an example of a complete setup with 4 silos.

Level monitoring system Nivotec NT 1000

Pos. 1 **Basic configuration**

NT 1000

- Pos. 2 **Control cabinet**
 Nivotec selection with or without control cabinet
 Z without control cabinet
 A with control cabinet
 B with control cabinet including SLS control

- Pos. 3 **Input signal**
 Type of input signal for the Nivotec system
 A Modbus
 B 4 analogue signals 4-20mA and 7 digital signals
 C 8 analogue signals 4-20mA and 14 digital signals

- Pos. 4 **Terminal box**
 Clamping between all level measurement signals such as on silo frame
 Z without
 K with

- Pos. 5 **Remote function**
 Visualisation can be used on a PC via an Ethernet interface
 incl SD card on the touch panel for software update
 Z without
 R with

- Pos. 6 **Number of vessels / silos**

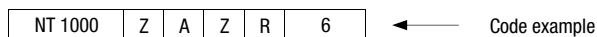
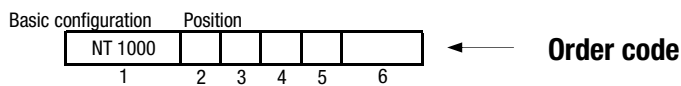

NT 2000

Characteristics

- Fill level indication on an LED display in percentage, height, volume or weight
- Simple and easy handling of the various display elements
- Evaluation of the analogue 4-20 mA signals of any number of sensors
- Fill control via full alarm signals and shut off valves
- Separate lorry module for safe and comfortable monitoring during silo filling

NT 2000 as an individual control cabinet

The NT 2000 offers all of the level indication modules and monitoring functions integrated in a control cabinet.

The fill level indication is via the Nivotec® NT 10 digital display, the level limits are via full and empty LEDs. 4-20 mA and digital signals from the measurement technology are evaluated. It is possible to integrate an alarm signal via an acoustic buzzer or optical flashing light which signals when the silo is full during filling. The buzzer or blinking light for when the silo is full can also be directly mounted on the silo. The NT 2000 can also be integrated with an automatic shut off valve function. The valve in the filling pipes then turns off when the silo is registered as full and thus prevents overfilling. All control functions of the alarm signal "full" or the shut off valve are integrated in the control cabinet and are controlled from there. The shut off valve is actuated via a key switch.

The NT 2000 is a complete system which also provides the supply voltage for the sensors. It is delivered with the project specific electrical plans.

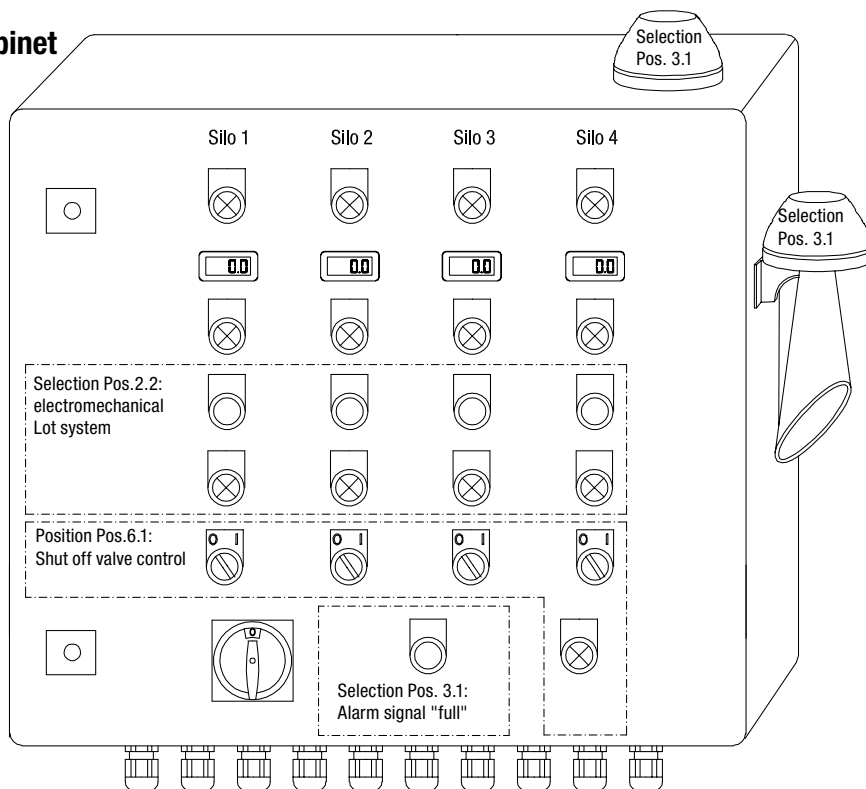

Additional lorry module

Both of the functions, full alarm signal and the shut off valves can be operated and displayed directly on the silo frame via the lorry module. The silos which have been cleared for filling are shown by LEDs, as well as which silos are empty or full. The full alarm signal is acknowledged on the lorry module.

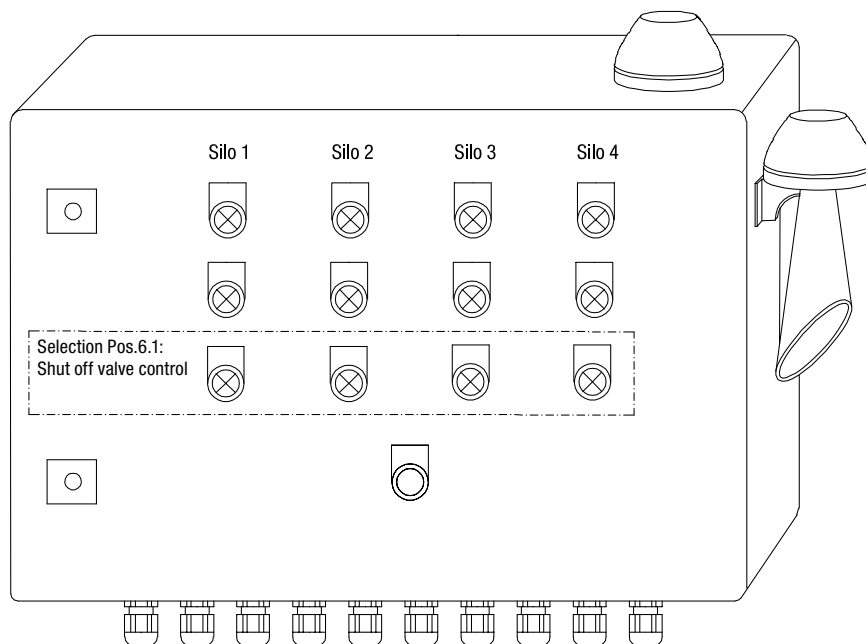

The drawing shows the sequence and principal positioning of the elements for an example of a complete setup with 4 silos.

Level monitoring system Nivotec NT 2000

Pos. 1 Basic configuration

NT 2000

- Pos. 2 **Measurement technology**
 Type of measurement technology which shall be connected to
 1 Only electronic measurement technology
 2 electromechanical Lot system
- Pos. 3 **Alarm signal "full"**
 Alarm signal "full" with buzzer or flashing light.
 LED and acknowledgement key in the main cabinet.
 If the lorry unit is selected (pos 4) please select Z for this position
 Z without
 1 with
- Pos. 4 **Lorry module (includes Pos. 3)**
 Alarm signal "full" with buzzer or flashing light. Acknowledgement key.
 LED for full and empty detection.
 Z without
 L with
- Pos. 5 **Terminal box**
 Clamping between all level measurement signals such as on silo frame
 Z without
 K with
- Pos. 6 **Shut off valve control**
 Automatic shut off with full signal
 Z Without
 1 Filling release via key switch
- Pos. 7 **Number of vessels / silos**

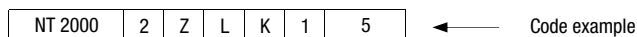
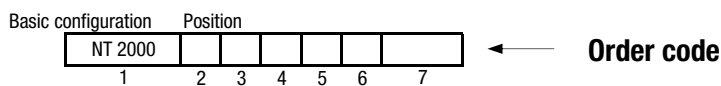

NT 3000

Characteristics

- Fill level visualisation via web server module
- Visualisation via standard Internet browser software on all Ethernet PCs can be simultaneously operated
- Password protected
- Worldwide remote enquiry of the level - password protected
- Software operation additional via a touch panel in the control cabinet possible or the usual fill level indication via LED display in percentage, height, volume or weight and full and empty LEDs
- Trend displays and data storage
- Evaluation of the analogue 4-20 mA signals of any number of sensors, as well as Modbus RTU of the Nivowave® systems
- Fill control via full alarm signals and shut off valves
- Separate lorry module for safe and comfortable monitoring during silo filling

NT 3000 as an individual control cabinet

The heart of the NT 3000 is the web server module, which the visualisations software uses. All fill level control and display functions can be used via the visualisation. An Ethernet interface ensures that the visualisation can be simultaneously operated from all PCs that are connected to the interface. Access is password protected. Additionally it is possible for the control cabinet to be equipped with user and display elements. Either the 7" or 12.1" touch panel or the Nivotec® NT 10 digital display with full and empty LEDs can be chosen. The electromechanical Lot can also be started. The buzzer or blinking light for when the silo is full can also be directly mounted on the silo. All control functions of the alarm signal "full" or the shut off valve are integrated in the control cabinet and are controlled from there. The shut off valve can either be operated via a key switch, Mouse click or operator panel, barcode reader or transponder chip. The NT 3000 is a complete system which also provides the supply voltage for the sensors. The NT 3000 offers alongside the Ethernet interface also the Profibus DP interface. The system is delivered with project specific electrical plans.

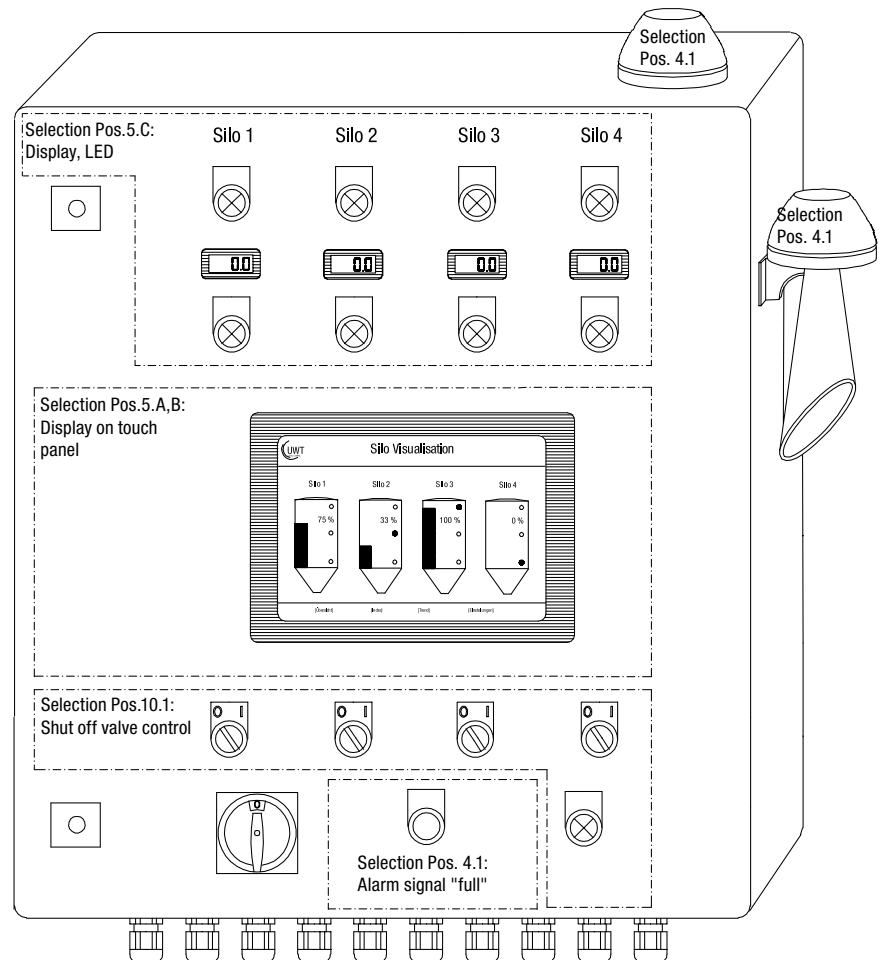

The drawing shows the sequence and principal positioning of the elements for an example of a complete setup with 4 silos.

Additional lorry module

Both of the functions, full alarm signal and the shut off valves can be operated and displayed directly on the silo via the lorry module.

The silos which have been cleared for filling are shown by LEDs, as well as which silos are empty of full. The full alarm signal is acknowledged on the lorry module.

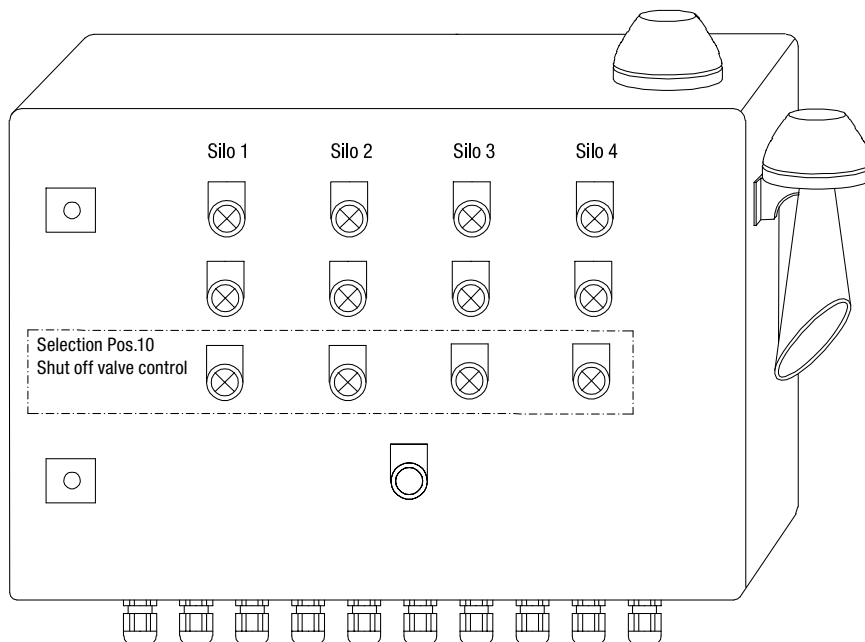

Level monitoring system Nivotec NT 3000

Pos. 1 Basic configuration

NT 3000

Pos. 2

Measurement technology

Type of measurement technology

- 1 Only electronic measurement technology
- 2 electromechanical Lot system

Pos. 3

Input signal

Type of input signal

- B Modbus and digital signal
- A analogue 4-20 mA signale and digital signal

Pos. 4

Alarm signal "full"

Alarm signal "full" with buzzer or flashing light.

LED and acknowledgement key in the main cabinet.

If the lorry unit is selected (pos 4) please select Z for this position

- Z without
- 1 with

Pos. 5

Display in the control cabinet door

Type of visual display

- Z Without
- A 7" visualisation on a touch panel
- B 12.1" visualisation on a touch panel
- C Digital display of level and LEDs for full and empty detection (only with position 3A)

Pos. 6

Remote data enquiry

Password protected remote data enquiry

- Z Without
- M Modem



NT 3000

- Pos. 7 **Data storage and trends**
 Data recording on a storage card with data readout
 Z without
 S with
- Pos. 8 **Lorry module (includes Pos. 3)**
 Alarm signal "full" with buzzer or flashing light. Acknowledgement key.
 LED for fully and empty detection.
 Z without
 L with
- Pos. 9 **Terminal box**
 Clamping between all level measurement signals such as on silo frame
 Z without
 K with
- Pos. 10 **Shut off valve**
 Automatic shut off with full signal. Various release types available
 Z Without
 1 Filling release via key card
 2 Filling release via mouse click in the visualisation software
 3 Filling release via number input on the operator panel
 4 Filling release via a barcode scanner incl. scanner
 5 Filling release via transponder chip
- Pos. 11 **Profibus interface**
 Interface for the output of the control cabinet
 Z without
 P with
- Pos. 12 **Number of vessels / silos**

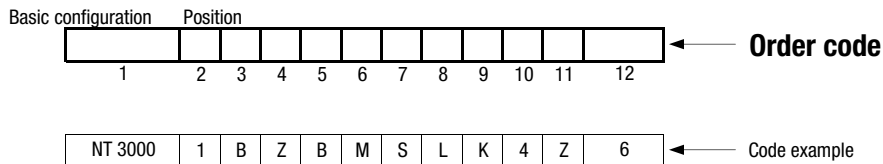

Accessories

Transponder chip reader

Scans the transponder chips and is mounted near the lorry module.

Transponder chips

3 Chips as spares or for further chip scanners

Accessories

Display modules digital or analogue

Nivotec NT 10 / 20 / 30 / 40

Page

NT 10
Digital meter, current loop display 4 - 20 mA

P12



NT 20
Digital meter, signal input 0 - 20 mA, 4 - 20 mA, 0 - 10 V,
2 point levels programmable

P12



NT 30
digital meter, impulse input counter, 2 point levels programmable

P13



NT 40
Analogue meter, signal input 4-20mA

P13



Accessories

NT 10

Digital meter for fill level display in percentage, weight, volume or height. Current loop display 4-20mA



Dimensions 48mm x 24mm, 7 Segment LED, 10mm, red
 Dimensions 72mm x 36mm, 7 Segment LED, 14mm, red

NT 10-1
 NT 10-2

Wiring connections

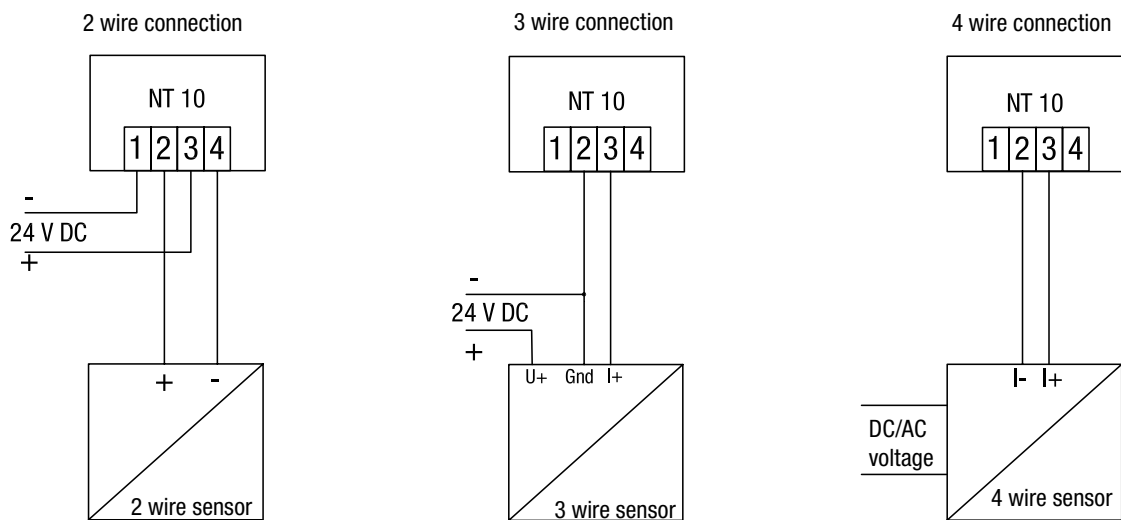

NT 20

digital meter for fill level display in percentage, weight, volume or height.

Signal input 4-20mA, 7 Segment LED, 10mm, red, dimensions 96mm x 24mm, 2 programmable relays



Supply voltage 230 VAC
 Supply voltage 24 VDC

NT 20-1
 NT 20-2

Electrical wiring

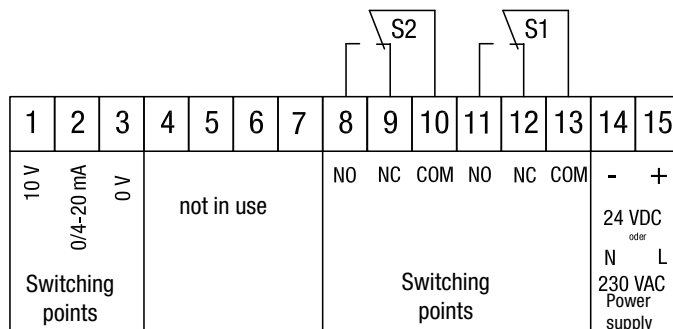

Accessories

NT 30

Digital meter for fill level display in percentage, weight, volume or height.

Impulse input counter, 7 Segment LED, 14mm, red, dimensions 72mm x 36mm, 2 programmable relays as open or closed contacts



Supply voltage 24 VDC

NT 30-1

Electrical wiring

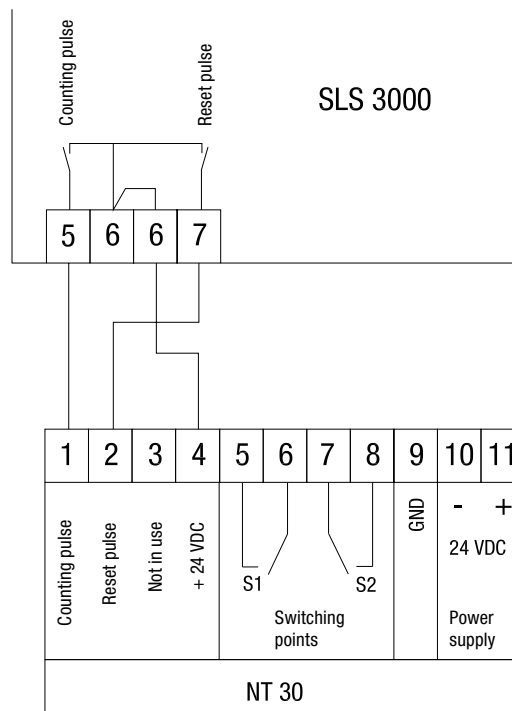

NT 40

Analogue meter for fill level display in percentage

Signal input 4-20mA, Display instrument, scale 0 - 100

Dimensions 72mm x 72mm

NT 40-1

Dimensions 96mm x 96mm

NT 40-2

Electrical wiring

Clamps	Function
1	Signal input +
2	Signal input -

